



POWERED MIXER

# EMX SERIES

EMX7/ EMX5/ EMX2/ EMX5016CF/ EMX5014C





POWERED MIXER

# EMX SERIES

EMX7/ EMX5/ EMX2/ EMX5016CF/ EMX5014C

## Power. Portability. Performance.

Ever since the launch of the first EM series integrated mixer in 1976, and the subsequent release of the first EMX console, Yamaha has remained the industry leader for powered mixers. Each model of the new EMX lineup is an integrated solution that combines a power amplifier with a versatile mixer in a single, compact unit with functionality and professional performance features tailored to the demands of various sound reinforcement environments.



POWERED MIXER

# EMX7 EMX5

## Get Serious About Your Sound

The new EMX7 and EMX5 were designed specifically for musicians, performers, or public speakers who put a premium on sound quality and convenient operation, and are ready to take their sound reinforcement to the next level. Despite their compact construction, only speakers and a microphone are required to configure a fully functioning, extremely portable, and reliable sound system with all the tools you need to mix, process, and deliver your audio just the way you want, anywhere you want.



### Powerful & High Efficiency Class-D Amplifier

The EMX7 and EMX5 models feature a built-in high-efficiency power amplifier of 2 x 710W and 2 x 630W of output power respectively. Despite their low power consumption, these amps are capable of very high volume output, yet still manage to remain surprisingly lightweight. Both models also come equipped with an onboard overload protection function to improve reliability and prolong component life and performance quality.



### Robust But Extremely Portable Design

The EMX7 and EMX5 benefit from a robust and portable design with a rugged, impact-resistant, powder-coated metal chassis geared towards extended operation and road usage. Large handles on the front and back of the enclosure make it extremely portable, and also help to protect knobs and terminals on the surface of the chassis from impact or pressure during transport.



### Easy Setup, Easy Operation

With their intuitive, user-friendly architecture, the EMX7 and EMX5 can be setup and operated quickly and easily by users with a fundamental understanding of sound reinforcement. Their versatile enclosure design allows users to choose from a variety of vertical or horizontal placements depending on the type of application. From a tabletop, floor, or installation environment no matter used on a tabletop or from a seated position with the mixer placed on the floor.



### Complete Range of Input & Output Channels

Both the EMX7 and EMX5 are equipped with four mono input channels and four mono/stereo input channels, allowing up to 8 microphones, and line-level devices such as keyboards and portable playback device to be connected to each channel. In addition, channel 4 can be used with Hi-Z inputs to connect instruments such as guitars or basses directly. Each model is also equipped with 2 AUX SEND connections for a monitoring system or external effect devices, REC OUT unbalanced RCA pin output jacks to connect an external recorder, and STEREO OUT TRS phone jacks to output the mixed stereo signal.



## Speaker Processor and Preset

EMX7 only

The speaker processor function allows you to select an appropriate setting to match the particular speakers you're using. It features presets specifically tuned for each model in Yamaha's extensive lineup of passive speakers, including CBR, Club, A and R series. This allows users to optimize speaker performance and save even more time during system setup. It also includes a bass boost function that can be enabled to significantly bring out the lower frequencies.

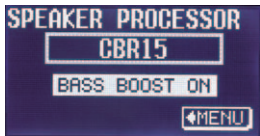

## Onboard Feedback Suppressor

Few things make a live performance or speaking engagement take a negative turn like the sudden, uncomfortable, and often embarrassing howling of unwanted feedback. EMX7/5 come equipped with a Feedback Suppressor that utilizes a unique Yamaha digital technology to instantly eliminate annoying feedback with the single switch of a button, which utilizes a seven-band notch filter.



## 3-band Equalizer Control

With individual knobs you can adjust the [HIGH], [MID], and [LOW] audio frequencies. You can operate instantly turning the control to amplify (boost) and attenuate (cut) the corresponding frequency band.



## Flex 9 Graphic Equalizer

EMX7 only

EMX7 is equipped with Flex-type graphic equalizer (Flex9GEQ) that allows you to select up to nine bands out of a total of 31 for fine tuning  $\pm 15$  dB.



## 1-Knob Master EQ™

EMX5 only

EMX5's 1-Knob Master EQ™ lets you apply optimized EQ settings with the simple turn of a knob. The SPEECH setting is geared towards meetings, seminars, or conferences with a limited lower end for clear, defined speech; MUSIC offers a more balanced sound tailored to acoustic or band performances; and BASS BOOST is ideal for DJ performances or audio playback that puts a priority on emphasizing the base sound.



## 1-knob COMP

EMX7/5 is equipped with the popular 1-knob COMP function used in MGP and MG series models. By simply operating a single control, it is possible to get optimal compression for vocals and instruments. As the [COMP] control is turned to the right, the threshold, ratio, and output gain are adjusted simultaneously.



## Rack-Mounting

EMX7/5 can be mounted onto a 19-inch rack by using the RK-EMX7 (rack-mount kit) sold separately.



## Comprehensive, Professional Effects and Signal Processing

EMX7/5 are equipped with a powerful, comprehensive DSP section that provides a total of 24 different effects that are in the same league as our famed SPX effect processor series used by professionals. It is possible to add reverb and delay effects that simulate the sound of different performance environments, such as concert halls and small clubs.

- |               |                 |
|---------------|-----------------|
| 1 REV HALL 1  | 13 VOCAL ECHO   |
| 2 REV HALL 2  | 14 KARAOKE      |
| 3 REV ROOM 1  | 15 PHASER       |
| 4 REV ROOM 2  | 16 FLANGER      |
| 5 REV STAGE 1 | 17 CHORUS 1     |
| 6 REV STAGE 2 | 18 CHORUS 2     |
| 7 REV PLATE   | 19 SYMPHONIC    |
| 8 DRUM AMB    | 20 TREMOLO      |
| 9 EARLY REF   | 21 AUTO WAH     |
| 10 GATE REV   | 22 RADIO VOICE  |
| 11 SINGLE DLY | 23 DISTORTION   |
| 12 DELAY      | 24 PITCH CHANGE |

## Flexible Speaker Connectivity

EMX7/5 are equipped with speaker jacks which can be used with both TS phone and speakON plugs.



## Internal Universal Power Supply

EMX7/5 have a highly-efficient internal universal power supply, then offer worry-free operation in any region around the globe—even in environments prone to potentially damaging power fluctuations. An internal power supply also simplifies rack mounting of the console for installed applications, eliminating the need for a bulky adapter or additional connections.





POWERED MIXER

# EMX2

## Easy Does It



The EMX2 is the most compact and portable model in the EMX lineup, yet despite its diminutive size, users can set up a fully functioning sound reinforcement system with the addition of speakers and microphones. This makes it easy for newcomers with little or no audio experience to easily configure their own sound system. The EMX2's all-in-one design concept ensures that by just plugging in a single power cable and making a few simple connections, anyone can be their own sound engineer.

### Premium Portability

Despite being a mixer and an amplifier in a single unit, the EMX2's dimensions (37.5cm x 22cm x 14.7cm / 14.8" x 5.8" x 8.7") are surprisingly modest, making it easy to fit along with speakers even in the trunk of a small car.

The lightweight body also features handles for a superior level of portability that will benefit anyone setting up a PA for applications where time is a consideration.



	Inputs	Output Power		1-knob COMP	SPX	GEQ	1-Knob Master EQ™	Speaker Preset	Feedback Suppressor	Universal Power Supply	Dimensions
		1 kHz THD+N < 10% (CEA2006)	1 kHz THD+N < 1% (CEA2006)								
 <b>EMX7</b>	Mono: 8, Stereo: 4	710W+710W (4 Ω) 500W+500W (8 Ω)	600W+600W (4 Ω) 400W+400W (8 Ω)	○	24 programs	○	-	○	○	○	465 × (18.3" ×
 <b>EMX5</b>		630W+630W (4 Ω) 460W+460W (8 Ω)	500W+500W (4 Ω) 370W+370W (8 Ω)	○	24 programs	-	○	-	○	○	465 × (18.3" ×
 <b>EMX2</b>	Mono: 4, Stereo: 3	250W+ 250W (4 Ω) 170W+170W (8 Ω)	110W+110W (4 Ω) 110W+110W (8 Ω)	-	Reverb 4 programs	-	○	-	○	○	375 × (14.8"×

## From Speaking Engagements to Live Bands and DJ Events

The EMX2's flexible connectivity allows you to use up to 4 microphones for singing along with musical instruments, or speaking/ making announcements along with BGM or recorded audio from a portable playback device. The unit also comes equipped with Phantom Power and high-impedance input capability allowing you to use high-performance condenser microphones or connect guitars directly without any external gear. And because the EMX2 is also an amplifier, you can easily connect passive speakers to complete your sound system, or even add a Yamaha DXS Series Powered sub-woofer via a single connection, for configuring a PA system for applications that require a more prominent bass performance, such as a DJ event in a small club or outdoor venue.

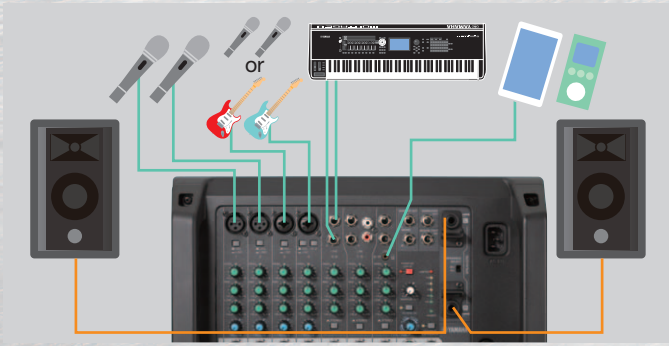

## 4 Yamaha Reverbs for Additional Atmosphere

For decades, the sound specialists at Yamaha have been developing high-quality reverb effects to add an atmospheric touch to our users vocal and instrumental performances. The EMX2 features some of the most commonly used and practical reverb algorithms, using a single knob to easily select and control the depth for one of four effects; HALL mimics the sound characteristics of a large hall, PLATE for a more classic, defined sound, ROOM adds a more intimate sound to performances, and ECHO gives instruments or vocal a more professional edge, as well as being an attractive option for KARAOKE.

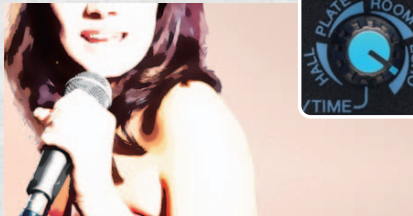

## A Positive Feedback Feature

Few things make a live performance or speaking engagement take a negative turn like the sudden, uncomfortable, and often embarrassing howling of unwanted feedback. Luckily the EMX2 comes equipped with a Feedback Suppressor that utilizes a unique Yamaha digital technology to instantly eliminate annoying feedback with the single switch of a button.



## Shape Your Sound

For adding the final touch to your mix, the EMX2's 1-Knob Master EQ™ lets you apply optimized EQ settings with the simple turn of a knob. The SPEECH setting is geared towards meetings, seminars, or conferences with a limited



lower end for clear, defined speech; MUSIC offers a more balanced sound tailored to acoustic or band performances; and BASS BOOST is ideal for DJ performances or audio playback that puts a priority on emphasizing the base sound.

## Flexible Setup for a Diverse Range of Applications

Using an optional rack-mount kit, you can seamlessly add the EMX2 to a rack configuration or and existing installed application.

You can even mount the EMX2 on a microphone stand using a simple mic-stand adaptor, giving you quick, convenient, manual control of all the relevant features.



(W x H x D)	Net Weight	Rack-mount kit	Mic Stand Adaptor	Foot Switch
308 x 325 mm 12.1" x 12.8"	9.5 kg (20.9 lbs)	RK-EMX7	-	FC5
308 x 325 mm 12.1" x 12.8"	9.5 kg (20.9 lbs)	RK-EMX7	-	FC5
147 x 220 mm 5.8" x 8.7"	4.2 kg (9.3 lbs)	RK-EMX2	BMS-10A	FC5

## Dimensions

### EMX7

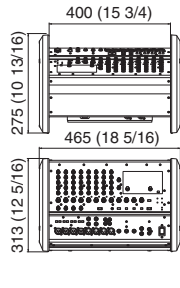

### EMX5

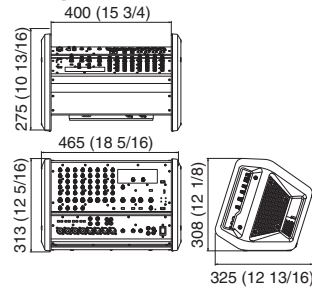

### EMX2 Unit: mm (inch)

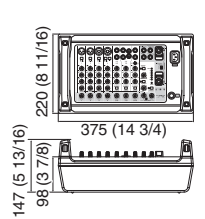

## Optional Accessories (sold separately)

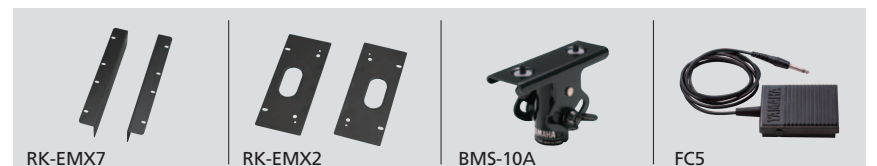

# EMX5016CF

## Serious Live Sound Capability Plus Innovative Digital Features

- Flagship EMX model with fader
- 500W + 500W Output Power (4  $\Omega$ )
- Up to 12 Mics, 16 Inputs Total (8 Mono/Mic, 4 Stereo)
- Dual SPX Sends
- FRC (Frequency Response Correction) System
- Feedback Suppressor
- 9-band Digital Graphic EQ with Presets & Memory



### Versatile 16-Input Configuration Adapts to Varied Source Requirements

The EMX5016CF has a total of 16 input channels – eight for monaural microphone or line input plus four stereo pairs which can function either as monaural microphone inputs or stereo line inputs giving you more options if your sources are mostly microphones. If you need to handle more stereo sources the EMX5016CF will comfortably handle four pairs in addition to eight monaural microphone or line inputs. Switchable phantom power is provided for all microphone inputs.

### Advanced Channel EQ

3-band EQ is available on all input channels, but extra versatility is provided on the eight mono channels with mid-frequency sweep controls. The mid EQ center frequency can be continuously swept from 250 Hz through 5 kHz so you can precisely pinpoint frequencies in the critical midrange that require compensation, providing significantly enhanced equalization potential.

### Ample I/O for Expansion and Integration

The EMX5016CF features a range of inputs and outputs that allow it to be expanded with external gear or integrated into larger systems. Insert patch points on the mono input channels, for example, let you add outboard signal processing to individual input channels, while external AUX and EFFECT sends allow you to route the mixer's signals to external signal processing and/or monitor systems. Stereo out, stereo sub-out, and record outputs are also provided.

### 1-knob COMP on Mono Channels

The EMX5016CF features compressors on all monaural microphone/line channels that can help to make vocals ride the mix better, give you that smooth compressed guitar sound, deliver more punchy bass, and generally refine your mixes in a multitude of ways. These unique 1-knob COMP are surprisingly simple to use. There are no multiple attack, threshold, makeup gain, and other controls – just set the COMP control to the amount of compression you need.

### FRC (Frequency Response Correction) System

Setting a live sound system's output equalizer to optimally match room response is normally a complicated process but the EMX5016CF handles the entire process automatically. Simply set up a microphone in an appropriate location, connect it to channel 1, press MEASURE/CORRECT once to make the measurement, and then again to automatically set the graphic equalizer for optimized response. The EQ setting can then be stored in one of the user memories for later recall.

### Automatic Feedback Suppression

The EMX5016CF provides a dedicated Feedback Suppressor function that detects feedback frequencies on the stereo bus and applies precise notch filters to eliminate the feedback. It has an AUTO mode that automatically keeps track of and attenuates feedback frequencies for you, and a sensitive manual mode that lets you pinpoint and attenuate individual feedback points.

### Multi-band "Maximizer"

The EMX5016CF "Maximizer" is an advanced 3-band compressor that can be applied to the stereo bus for a more punchy "up-front" overall sound. Simply press the MAXIMIZE switch to instantly give the mix more presence and impact without sacrificing musical subtlety.

### Dimensions

unit: mm (inch)

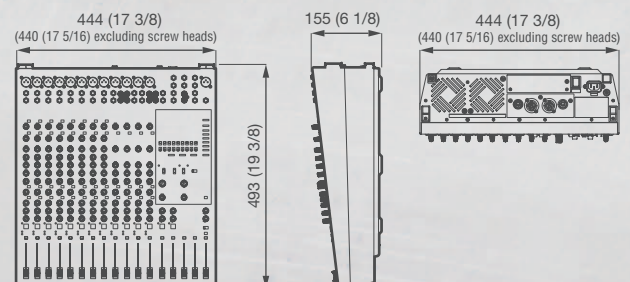

# EMX5014C

## A Console-format Powered Mixer for Advanced Live Applications

- Versatile EMX model with fader
- 500W + 500W Output Power (4 Ω)
- Up to 8 Mics, 14 Inputs Total (6 Mono/Mic, 4 Stereo)
- SPX Digital Effects
- FCL (Feedback Channel Locating) System
- 9-band Stereo Graphic EQ with Presets & Memory



### Console Controllability and Versatility

With the many features and control functions provided by the EMX5014C, console style is the only way to go. It's still compact enough to be placed in the stage area and controlled by the performers, but its console configuration also makes it an ideal choice for front-of-house type operation by sound engineers. Linear faders are another advantage of the console layout, providing precise level control as well as graphic representation of relative channel levels.

### Expanded EQ Capability

The EMX5014C features 3-band EQ on all input channels, but goes a step further on the six mono channels with mid-frequency sweep controls. The mid EQ center frequency can be continuously swept from 250 Hz through 5 kHz so you can precisely pinpoint frequencies in the critical midrange that require compensation or enhancement. The stereo graphic equalizer has also been expanded with 9 bands that can be used for more effective room voicing or feedback control.

### 1-knob COMP on Mono Channels

The EMX5014C features compressors on all six monaural mic/line channels allowing you to make vocals ride the mix better, give you that smooth compressed guitar sound, deliver more punchy bass, and generally hone your mixes in a multitude of ways. Yamaha's unique 1-knob COMP are simple to use, too. There's no need to juggle multiple attack, threshold, makeup gain, and other controls — just set the COMP control to the amount of compression you need.

### Feedback Channel Locating (FCL) System

FCL System indicator LEDs at the top of each channel light if the corresponding channel goes into feedback. So if and when feedback occurs you'll be able to locate the channel(s) in which it is occurring immediately and rectify the problem without delay.

### Comprehensive I/O

The EMX5014C features a range of inputs and outputs that allow it to be integrated into larger systems or add outboard gear. Insert patch points on the mono input channels, for example, let you add outboard signal processing to individual input channels, while external AUX and EFFECT sends allow you to route the mixer's signals to external signal processing and/or monitor systems as required. Stereo out, stereo sub-out, and record outputs are also provided.

### Dimensions

unit: mm (inch)

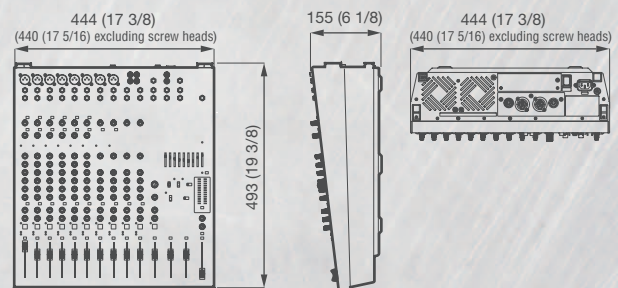

### Optional Accessories for EMX5016CF/5014C (sold separately)

Rack-Mount kit  
RK5014

Foot Switch  
FC5



# EMX7 / EMX5 / EMX2 General Specifications

0 dBu = 0.775 Vrms, Output impedance of signal generator (Rs) = 150 Ω. All level controls are at their maximum position if not specified.

MODEL		EMX7		EMX5		EMX2	
Output Power	1 kHz THD+N < 10% (CEA2006)	710 W + 710 W (4 Ω) 500 W + 500 W (8 Ω)		630 W + 630 W (4 Ω) 460 W + 460 W (8 Ω)		250 W + 250 W (4 Ω) 170 W + 170 W (8 Ω)	
	1 kHz THD+N < 1% (CEA2006)	600 W + 600 W (4 Ω) 400 W + 400 W (8 Ω)		500 W + 500 W (4 Ω) 370 W + 370 W (8 Ω)		110 W + 110 W (4 Ω) 110 W + 110 W (8 Ω)	
Frequency Response	Refer to the nominal output level @ 1 kHz	Input to SPEAKERS	Input to STEREO OUT, AUX1 SEND, AUX2 SEND	Input to SPEAKERS	Input to STEREO OUT, AUX1 SEND, AUX2 SEND	Input to SPEAKERS	Input to MONITOR OUT
		+1 dB/-3 dB (40 Hz to 20 kHz)	+0.5 dB/-1 dB (20 Hz to 20 kHz)	+1 dB/-3 dB (40 Hz to 20 kHz)	+0.5 dB/-1 dB (20 Hz to 20 kHz)	1 dB/-4 dB (40 Hz to 20 kHz)	+0.5 dB/-1.5 dB (20 Hz to 20 kHz)
Total Harmonic Distortion *1 (THD+N)		MIC/LINE = LINE (CH1-4) 0.1% @ 10 W (40 Hz to 20 kHz) 0.04% @ 65 W (1 kHz)	MIC/LINE = LINE (CH1-4) 0.02% @ +14 dBu (20 Hz to 20 kHz) 0.007% @ +20 dBu (1 kHz)	0.1% @ 10 W (40 Hz to 20 kHz) 0.05% @ 50 W (1 kHz)	0.03% @ +14 dBu (20 Hz to 20 kHz) 0.007% @ +20 dBu (1 kHz)	0.2% @ 13.8 W (40 Hz to 20 kHz) 0.4% @ 23.2 W (1 kHz)	0.05% @ +10 dBu (20 Hz to 20 kHz) 0.009% @ +20 dBu (1 kHz)
Hum & Noise *2 (20 Hz to 20 kHz)	Equivalent Input Noise	-117 dBu					
	Residual Output Noise	-70 dBu (40 Hz to 20 kHz, STEREO MASTER LEVEL: min)	-82 dBu (20 Hz to 20 kHz, STEREO MASTER LEVEL: min)	-70 dBu (40 Hz to 20 kHz, STEREO MASTER LEVEL: min)	-82 dBu (20 Hz to 20 kHz, STEREO MASTER LEVEL: min)	-68 dBu (40 Hz to 20 kHz, MASTER: min)	-99 dBu (20 Hz to 20 kHz, MONITOR: min)
Crosstalk (1 kHz) *3		-85 dB					
Input Channels		TOTAL: 12 channels Mono (MIC/LINE): 8, Stereo (LINE): 4					
Output Channels		SPEAKERS [A, B], AUX1 SEND, AUX2 SEND, STEREO OUT [L, R], REC OUT [L, R]					
Bus		Stereo: 1, AUX: 2 (Including FX) MIC/LINE (CH1-4): 30 dB PAD Hi-Z (CH4): Supported HPF (CH1-3) 80 Hz, -12 dB/oct. Equalizer (EQ): HIGH: 10 kHz +15 dB / -15 dB (Shelving) MID: 2.5 kHz +15 dB / -15 dB (Peaking) LOW: 100 Hz +15 dB / -15 dB (Shelving) COMP (CH1-4): 1-knob COMP					
Input Channel Function		Stereo: 1, Effect: 1 PAD (CH1-4): 26 dB Hi-Z (CH4): Supported Equalizer (EQ): HIGH: 8 kHz +15 dB / -15 dB MID: 2.5 kHz +15 dB / -15 dB LOW: 100 Hz +15 dB / -15 dB					
Level Meter		2 x 12 points LED meter (-30, -25, -20, -15, -10, -6, -3, 0, +3, +6, +10, PEAK)				2 x 7 points LED meter (-20, -10, -6, 0, +6, +10, PEAK)	
Built-in Effect		SPX Algorithm					
Output Channel Function		24 programs					
Phantom Power Voltage		Feedback suppressor, Graphic equalizer, Speaker processor					
Foot Switch		Feedback suppressor, Master EQ, Monitor EQ					
Protection		Feedback suppressor, Master EQ (SPEECH to MUSIC)					
Power Requirements		+48 V					
Power Consumption		Effect mute on/off					
Dimensions (W x H x D)		Load Protection: DC-fault					
Net Weight		Amplifier Protection: Over heat protection, Over current protection, Integral power protection					
Optional Accessory		Power Supply Protection: Over heat protection, Over current protection					
Operating Temperature		AC 100-240 V, 50 Hz/60 Hz					
		45 W (Idle) / 250 W (1/8 Power)		42 W (Idle) / 210 W (1/8 Power)		35 W (Idle) / 90 W (1/8 Power)	
		465 mm x 308 mm x 325 mm (18 5/16" x 12 1/8" x 12 13/16")					
		375 mm x 147 mm x 220 mm (14 3/4" x 5 13/16" x 8 11/16")					
		9.5 kg (20.9 lbs)					
		4.2 kg (9.3 lbs)					
		Rack-mount brackets: RK-EMX7, Foot switch: FC5					
		Rack-Mount Kit: RK-EMX2, Mic Stand Adaptor: BMS-10A, Foot Switch: FC5					
		0 to +40°C					

\*1 THD+N is measured with 22 kHz LPF \*2 Noise is measured with A-weighting filter. \*3 Crosstalk is measured with 1 kHz band pass filter.

# EMX7 / EMX5 / EMX2 Input Characteristics

0 dBu = 0.775 Vrms

EMX7 / EMX5									
Input Jack	MIC/LINE	Hi-Z	Actual Load Impedance	For Use with Nominal	Input Level			Connector	
					Sensitivity *1	Nominal Level (▼ Position) *2	Max. Before Clip		
CH 1-4	XLR	MIC	—	3 kΩ	50-600 Ω Mics	-60 dBu (0.775 mV)	-43 dBu (5.48 mV)	-15 dBu (138 mV)	Combo jack *3 (Balanced)
		LINE	—			-30 dBu (24.5 mV)	-13 dBu (173 mV)	+15 dBu (4.36 V)	
	Phone	MIC	—	8 kΩ	600 Ω Lines	-50 dBu (2.45 mV)	-33 dBu (17.3 mV)	-5 dBu (436 mV)	
		LINE	—			-20 dBu (7.75 mV)	-3 dBu (548 mV)	+25 dBu (13.8 V)	
CH 4 (Hi-Z)	Phone	MIC	ON	1 MΩ	10 kΩ Lines	-50 dBu (2.45 mV)	-33 dBu (17.3 mV)	-5 dBu (436 mV)	Phone jack *4 (Unbalanced)
		LINE	—			-20 dBu (7.75 mV)	-3 dBu (548 mV)	+20 dBu (7.75 V)	
CH 5/6, 7/8	XLR	—	—	3 kΩ	50-600 Ω Mics	-60 dBu (0.775 mV)	-43 dBu (5.48 mV)	-15 dBu (138 mV)	XLR-3-31 *5 (Balanced)
		Phone	—			10 kΩ	600 Ω Lines	-20 dBu (7.75 mV)	
CH 9/10, 11/12	XLR	—	—	3 kΩ	50-600 Ω Mics	-60 dBu (0.775 mV)	-43 dBu (5.48 mV)	-15 dBu (138 mV)	Phone jack *4 (Unbalanced)
		Pin	—			10 kΩ	600 Ω Lines	-8 dBu (316 mV)	
CH 11/12	Mini jack	—	—	10 kΩ	600 Ω Lines	-8 dBu (316 mV)	+10 dBu (2.45 V)	+25 dBu (13.8 V)	Stereo mini jack *6 (Unbalanced)

EMX2									
Input Jack	MIC/LINE	Hi-Z [CH4]	Actual Load Impedance	For Use with Nominal	Input Level			Connector	
					Sensitivity *1	Nominal	Max. Before Clip		
CH1 - 4 [XLR]	MIC	—	3 kΩ	150 Ω Mics	-56 dBu (1.228 mV)	-35 dBu (13.78 mV)	-10 dBu (245.1 mV)	CH1, 2 XLR-3-31 *5 (Balanced) CH3, 4 Combo jack *3 (Balanced)	
	LINE	—	3 kΩ	150 Ω Lines	-30 dBu (24.51 mV)	-9 dBu (275.0 mV)	+16 dBu (4.890 V)		
CH3, 4 [Phone]	MIC	OFF	3 kΩ	10 kΩ Lines	-50 dBu (2.451 mV)	-29 dBu (27.50 mV)	-4 dBu (489.0 mV)		
		ON	1 MΩ	10 kΩ Lines	-24 dBu (48.90 mV)	-3 dBu (548.7 mV)	+22 dBu (9.757 V)		
	LINE	OFF	3 kΩ	150 Ω Lines	-24 dBu (48.90 mV)	-3 dBu (548.7 mV)	+22 dBu (9.757 V)		
		ON	1 MΩ	10 kΩ Lines	-24 dBu (48.90 mV)	-3 dBu (548.7 mV)	+22 dBu (9.757 V)		
CH5/6 - 9/10	—	—	10 kΩ	150 Ω Lines	-24 dBu (48.90 mV)	-3 dBu (548.7 mV)	+22 dBu (9.757 V)	CH5/6 Phone jack *4 (Unbalanced) CH7/8 Phone jack *4 & RCA pin (Unbalanced) CH9/10 Phone jack *4 & Stereo mini jack (Unbalanced)	

\*1 Sensitivity is the lowest level that will produce an output of +4 dBu (1.228 V) or the nominal output level when the unit is set to maximum gain. (All level controls are at their maximum position.) \*2 Level controls setting: Channel level controls are at their 1 position. Master level controls are at their maximum position. \*3 1&Sleeve = GND, 2&Tip = HOT, 3&Ring = COLD \*4 Tip = Signal, Sleeve = GND \*5 1 = GND, 2 = HOT, 3 = COLD \*6 Tip = LEFT, Ring = RIGHT, Sleeve = GND

# EMX7 / EMX5 / EMX2 Output Characteristics

0 dBu = 0.775 Vrms 0 dBV = 1.00 Vrms

EMX7 / EMX5					
Output Jack	Actual Source Impedance	For Use with Nominal	Output level		Connector
			Nominal	Max. Before Clip	
STEREO OUT L, R	600 Ω	10 kΩ Lines	+4 dBu (1.228 V)	+20 dBu (7.75 V)	Phone jack *1 (Impedance balanced)
AUX SEND 1, 2	600 Ω	10 kΩ Lines	+4 dBu (1.228 V)	+20 dBu (7.75 V)	Phone jack *1 (Impedance balanced)
REC OUT L, R	600 Ω	10 kΩ Lines	-10 dBV (0.308 V)	+18 dBV (7.75 V)	RCA pin (Unbalanced)

\*1 Tip = HOT, Ring = COLD, Sleeve = GND

EMX2					
Output Jack	Actual Source Impedance	For Use with Nominal	Output Level		Connector
			Nominal	Max. Before Clip	
MONITOR OUT [L, R]	150 Ω	10 kΩ Lines	+4 dBu (1.23 V)	+20 dBu (7.75 V)	Phone jack *1 (Impedance balanced)
SUBWOOFER OUT	150 Ω	10 kΩ Lines	-3 dBu (0.55 V)	+17 dBu (5.49 V)	Phone jack *1 (Impedance balanced)

# EMX7 / EMX5 / EMX2 Speaker Output Characteristics

0 dBu = 0.775 Vrms

EMX7 / EMX5							
Output Jack	Actual Source Impedance	For Use with Nominal	Output level				Connector
			1 kHz THD+N < 1% (CEA2006)	1 kHz THD+N < 10% (CEA2006)	EMX7	EMX5	
SPEAKERS A, B	< 0.1 Ω	4 Ω Speakers	600 W	500 W	710 W	630 W	speakON N4 *1 Phone jack *2
			400 W	370 W	500 W	460 W	

\*1 1+ = Positive, 1- = Negative \*2 Tip = Positive, Sleeve = Negative

EMX2					
Output Jack	Actual Source Impedance	For Use with Nominal	Output Level		Connector
			1 kHz THD+N < 1%	1 kHz THD+N < 10% (CEA2006)	
SPEAKERS [L, R]	< 0.1 Ω	4 Ω Speakers	110 W	250 W	Phone jack *1
			110 W	170 W	

\*1 Tip = Positive, Sleeve = Negative

## EMX5016CF / EMX5014C General Specifications

MODEL	EMX5016CF	EMX5014C
Output Power	500 W/4 Ω, 350 W/8 Ω (UA), 320 W/8 Ω (H)	
Frequency Response	-3, 0, 1 dB 20 Hz-20 kHz, ref to the 1 kHz output level, GAIN=MIN, PAD=OFF	-3, 0, 1 dB, 20 Hz-20 kHz ref to the nominal output level @ 1 kHz
Total Harmonic Distortion	Less than 0.3% (THD+N) +14 dBu output into 600 Ω @ 20 Hz-20 kHz	Less than 0.3% (THD+N) +14 dBu output into 600 Ω @ 20 Hz-20 kHz
Hum & Noise	Equivalent Input Noise, -128 dBu, GAIN=MAX, 20 Hz-20 kHz, CH1-8 MIC	Equivalent Input Noise, -128 dBu, GAIN=MAX, 20 Hz-20 kHz, ST OUT
Crosstalk (1kHz)	-68 dB	
Input Connectors	CH 1-8: XLR and Phone CH 9/10-15/16: XLR, Phone and Pin	CH 1-6: XLR and Phone CH 7/8, 9/10: XLR and Phone CH 11/12, 13/14: XLR and Pin
EQ	CH 1-8: HIGH (10 k, Shelving), MID (mono: 250-5 k, st: 2.5 k, Peaking), LOW (100, Shelving) CH 9/10-15/16: HIGH (10 k, Shelving), MID (st: 2.5 k, Peaking), LOW (100, Shelving)	HIGH (10 k, Shelving), MID (mono: 250-5 k, st: 2.5 k, Peaking), LOW (100, Shelving)
Phantom Power Voltage	48 V	
Graphic Equalizer	9 Band (63, 125, 250, 500, 1 k, 2 k, 4 k, 8 k, 16 kHz), Preset x 3, User preset x 3	
Digital Effects	SPX Digital Multi Effector (24 bit AD/DA, 32 bit Internal Processing): 16 Programs x 2	
Power Amp. Mode	L/R, AUX1/MONO, AUX1/2	
Foot Switch	Effect On/Off	
Power Requirement	120V /60 Hz, 220-240 V /50 Hz (Vary by region)	
Power Consumption	500W	450 W
Dimensions (W x H x D)	444 mm x 155 mm x 493 mm (17 3/8" x 6 1/8" x 19 3/8")	
Net Weight	11 kg (24.2 lbs.)	10.5 kg (23.1 lbs.)

All level controls are nominal, when measured. Output impedance of signal generator: 150 Ω

## EMX5016CF / EMX5014C Input Characteristics

EMX5016CF								
Input Terminals	PAD	GAIN	Actual Load Impedance	For Use With Nominal	Input Level			Connector
					Sensitivity *2	Position	Max. Before Clip	
CH INPUT A 1-8	0dB	-60 dB	3 kΩ	50-600 Ω Mics	-80 dBu (0.078 mV)	-60 dBu (0.775 mV)	-40 dBu (7.75 mV)	XLR-3-31 type *3
		-16 dB			-36 dBu (12.3 mV)	-16 dBu (123 mV)	+4 dBu (1.23 V)	
	26dB	-34 dB			-54 dBu (1.55 mV)	-34 dBu (15.5 mV)	-14 dBu (155 mV)	
		+10 dB			-10 dBu (245 mV)	+10 dBu (2.45 V)	+30 dBu (24.5 V)	
CH INPUT B 1-8	0dB	-60 dB	10 kΩ	600 Ω Lines	-80 dBu (0.078 mV)	-60 dBu (0.775 mV)	-40 dBu (7.75 mV)	Phone Jack *4
		-16 dB			-36 dBu (12.3 mV)	-16 dBu (123 mV)	+4 dBu (1.23 V)	
	26dB	-34 dB			-54 dBu (1.55 mV)	-34 dBu (15.5 mV)	-14 dBu (155 mV)	
		+10 dB			-10 dBu (245 mV)	+10 dBu (2.45 V)	+30 dBu (24.5 V)	
ST CH MIC INPUT 9/10-15/16	—	-60 dB	3 kΩ	50-600 Ω Mics	-80 dBu (0.078 mV)	-60 dBu (0.775 mV)	-40 dBu (7.75 mV)	XLR-3-31 type *3
ST CH LINE INPUT 9/10-15/16	—	-16 dB	10 kΩ	600 Ω Lines	-36 dBu (12.3 mV)	-16 dBu (123 mV)	-10 dBu (245 mV)	Phone Jack *5 RCA pin Jack
		-34 dB			-54 dBu (1.55 mV)	-34 dBu (15.5 mV)	-14 dBu (155 mV)	
CH INSERT IN (1-8)	—	+10 dB	10 kΩ	600 Ω Lines	-10 dBu (245 mV)	+10 dBu (2.45 V)	+30 dBu (24.5 V)	Phone Jack *5
		—			-20 dBu (77.5 mV)	0 dBu (0.775 V)	+20 dBu (7.75 V)	

EMX5014C								
Input Terminals	PAD	GAIN	Actual Load Impedance	For Use With Nominal	Input Level			Connector
					Sensitivity *2	Position	Max. Before Clip	
CH INPUT A 1-6	0dB	-60 dB	3 kΩ	50-600 Ω Mics	-80 dBu (0.078 mV)	-60 dBu (0.775 mV)	-40 dBu (7.75 mV)	XLR-3-31 type *3
		-16 dB			-36 dBu (12.3 mV)	-16 dBu (123 mV)	+4 dBu (1.23 V)	
	26dB	-34 dB			-54 dBu (1.55 mV)	-34 dBu (15.5 mV)	-14 dBu (155 mV)	
		+10 dB			-10 dBu (245 mV)	+10 dBu (2.45 V)	+30 dBu (24.5 V)	
CH INPUT B 1-6	0dB	-60 dB	10 kΩ	600 Ω Lines	-80 dBu (0.078 mV)	-60 dBu (0.775 mV)	-40 dBu (7.75 mV)	Phone Jack *4
		-16 dB			-36 dBu (12.3 mV)	-16 dBu (123 mV)	+4 dBu (1.23 V)	
	26dB	-34 dB			-54 dBu (1.55 mV)	-34 dBu (15.5 mV)	-14 dBu (155 mV)	
		+10 dB			-10 dBu (245 mV)	+10 dBu (2.45 V)	+30 dBu (24.5 V)	
ST CH INPUT 7/8-9/10	—	-60 dB	3 kΩ	50-600 Ω Mics	-80 dBu (0.078 mV)	-60 dBu (0.775 mV)	-40 dBu (7.75 mV)	XLR-3-31 type *3
		-16 dB			-36 dBu (12.3 mV)	-16 dBu (123 mV)	-10 dBu (245 mV)	
	—	-34 dB	10 kΩ	600 Ω Lines	-54 dBu (1.55 mV)	-34 dBu (15.5 mV)	-14 dBu (155 mV)	Phone Jack *5
		+10 dB			-10 dBu (245 mV)	+10 dBu (2.45 V)	+30 dBu (24.5 V)	
ST CH INPUT 11/12-13/14	—	-34 dB	10 kΩ	600 Ω Lines	-54 dBu (1.55 mV)	-34 dBu (15.5 mV)	-14 dBu (155 mV)	*Phone Jack *5 RCA pin Jack
		+10 dB			-10 dBu (245 mV)	+10 dBu (2.45 V)	+30 dBu (24.5 V)	
CH INSERT IN (1-6)	—	—	10 kΩ	600 Ω Lines	-20 dBu (77.5 mV)	0 dBu (0.775 V)	+20 dBu (7.75 V)	Phone Jack *5

\*1 0 dBu is referenced to 0.775 Vrms. \*2 Sensitivity is the lowest level that will produce an output of +4 dBu (1.23 V), or the nominal output level when the unit is set to maximum level. (All level controls are at maximum position.)

\*3 XLR-3-31 type connectors are balanced. (1=GND, 2=HOT, 3=COLD) \*4 Phone Jacks are balanced. (Tip=HOT, Ring=COLD, Sleeve=GND) \*5 Phone Jacks are unbalanced.

## EMX5016CF / EMX5014C Output Characteristics

EMX5016CF					
Output Terminals	Actual Source Impedance	For Use With Nominal	Output Level		Connector
			Nominal	Max. Before Clip	
ST OUT [L, R]	150 Ω	600 Ω Lines	+4 dBu (1.23 V)	+20 dBu (7.75 V)	Phone Jack *2
ST SUB OUT [L, R]	150 Ω	600 Ω Lines	+4 dBu (1.23 V)	+20 dBu (7.75 V)	Phone Jack *2
AUX SEND 1, 2	150 Ω	600 Ω Lines	+4 dBu (1.23 V)	+20 dBu (7.75 V)	Phone Jack *2
EFFECT SEND 1, 2	150 Ω	600 Ω Lines	+4 dBu (1.23 V)	+20 dBu (7.75 V)	Phone Jack *2
CH INSERT OUT 1-8	600 Ω	10 kΩ Lines	0 dBu (0.775 V)	+20 dBu (7.75 V)	Phone Jack *2
REC OUT [L, R]	600 Ω	10 kΩ Lines	-10 dBV (316 mV)	+10 dBV (3.16 V)	RCA pin Jack
PHONES [L, R]	100 Ω	40 Ω Lines	3mW	75mW	Phone Jack (TRS)
SPEAKERS	0.1 Ω	4 Ω Speakers	125W	500W	speakON Phone Jack *2

EMX5014C					
Output Terminals	Actual Source Impedance	For Use With Nominal	Output Level		Connector
			Nominal	Max. Before Clip	
ST OUT [L, R]	150 Ω	600 Ω Lines	+4 dBu (1.23 V)	+20 dBu (7.75 V)	Phone Jack *2
ST SUB OUT [L, R]	150 Ω	600 Ω Lines	+4 dBu (1.23 V)	+20 dBu (7.75 V)	Phone Jack *2
AUX SEND 1, 2	150 Ω	600 Ω Lines	+4 dBu (1.23 V)	+20 dBu (7.75 V)	Phone Jack *2
EFFECT SEND	150 Ω	600 Ω Lines	+4 dBu (1.23 V)	+20 dBu (7.75 V)	Phone Jack *2
CH INSERT OUT 1-6	600 Ω	10 kΩ Lines	0 dBu (0.775 V)	+20 dBu (7.75 V)	Phone Jack *2
REC OUT [L, R]	600 Ω	10 kΩ Lines	-10 dBV (316 mV)	+10 dBV (3.16 V)	RCA pin Jack
PHONES [L, R]	100 Ω	8 Ω/40 Ω Lines	1mW/3mW	20mW/75mW	Phone Jack (TRS)
SPEAKER OUT	0.1 Ω	4 Ω Speakers	125W	500W	speakON Phone Jack *2

\*1 0 dBu is referenced to 0.775 Vrms. 0 dBV is referenced to 1 Vrms. \*2 Phone Jacks are unbalanced.

## Plug Types (not included in the EMX)

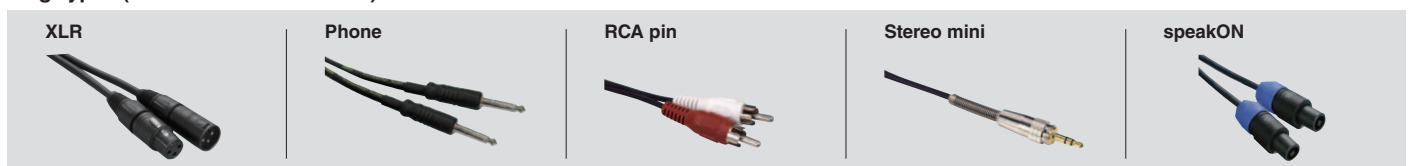

# Loudspeakers

# CBR Series

CBR10 CBR12 CBR15

## POWER TO PLAY

CBR Series passive loudspeakers were developed by adopting the extensive knowledge of speaker design and acoustic technologies that Yamaha has accrued over a storied history of making speakers of every kind. The primary focus was to deliver high-power, high-definition sound in a durable, portable design that is equally at home in front-of-house, floor monitoring, or rigged configurations. CBR speakers are ideally suited for use with EMX powered mixers to complete a high-performance, yet easily configured sound solution.



### Custom Designed Transducers and Wide-Dispersion Constant Directivity Horn for Powerful High-Definition Sound

CBR Series speakers come equipped with customized transducers that feature a highly responsive woofer and a precise 2.5" compression driver (CBR15) or 2" compression driver (CBR10 and CBR12), ensuring consistent high-definition sound even at high output levels. Additionally, a newly designed wide-dispersion constant directivity horn minimizes the radiation pattern deterioration that more conventional horns are prone to, allowing sound to expand in a more evenly dispersed rectangular pattern reaching the outer-most edges of the coverage area.



### HF Protection and Highly Responsive LF Unit for Reliable Performance at Any Output Level

Have you ever blown your speakers by cranking up the output levels beyond your speakers capabilities? CBR Series speakers employ a protection function that limits excessive input to the HF unit. This valuable protection circuit affords you worry-free operation of your speakers when you need them most. Combined with a highly responsive LF unit, CBR Series speakers reliably deliver clear, precise sound at any output level.

### Rugged, Highly Portable Enclosure Design

CBR Series speakers feature a very compact, durable, and lightweight plastic cabinet equipped with newly designed, ergonomic handles that greatly minimize system transport and setup. In addition, all CBR models feature a sleek, steel front grille that seamlessly blends in with installation aesthetics while protecting the vital inner speaker components from environmental hazards.

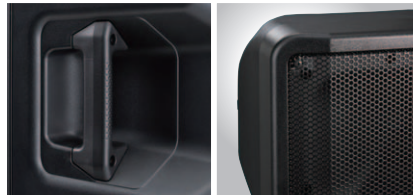

### Simple Connectivity

CBR Series speakers are equipped with one speakON jack and one 1/4" Phone jack that allow for fast and easy connectivity in both personal and professional environments.



### Versatility for a Wide Range of Applications

- Smart Enclosure Design for Floor Monitoring**  
 The CBR Series speakers feature an optimized 50° wedge angle for floor monitoring. In addition, the CBR12 and CBR15's symmetrical shape allows for effortless con guration of a mirror-mode floor monitoring system for a larger and more defined sweet spot.
- Rigging Points for Installation Applications**  
 CBR loudspeakers come equipped with M8 rigging points, allowing for rigged applications with optional speaker brackets or standardized eye-bolts.



	Power *1 Rating	Maximum *2 SPL	Frequency Range	LF	HF	Coverage Angle
CBR10	700W	123dB SPL	50Hz-20kHz	10" cone	1" diaphragm 1" throat	H90°xV60°
CBR12	700W	125dB SPL	48Hz-20kHz	12" cone	1.4" diaphragm 1" throat	H90°xV60°
CBR15	1000W	126dB SPL	46Hz-20kHz	15" cone	1.4" diaphragm 1" throat	H90°xV60°

\*1 Dynamic Power \*2 Measured Maximum SPL (peak)

### Optional Speaker Brackets (Sold Separately)



### Dimensions

Unit: mm (inch)

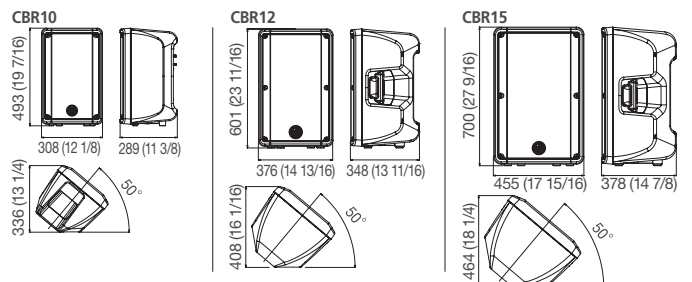

# EMX7 Block and Level Diagrams

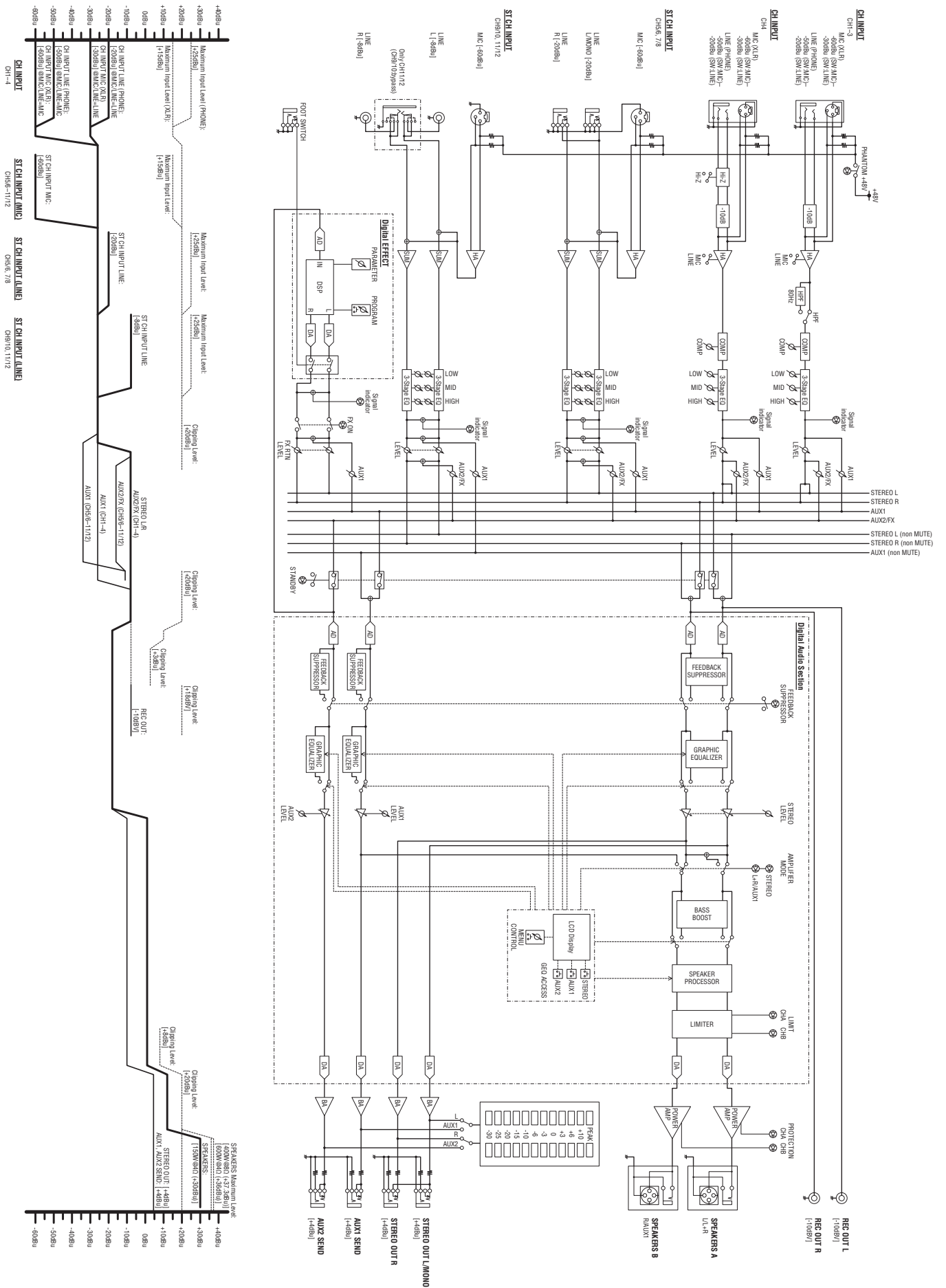

# EMX5 Block and Level Diagrams

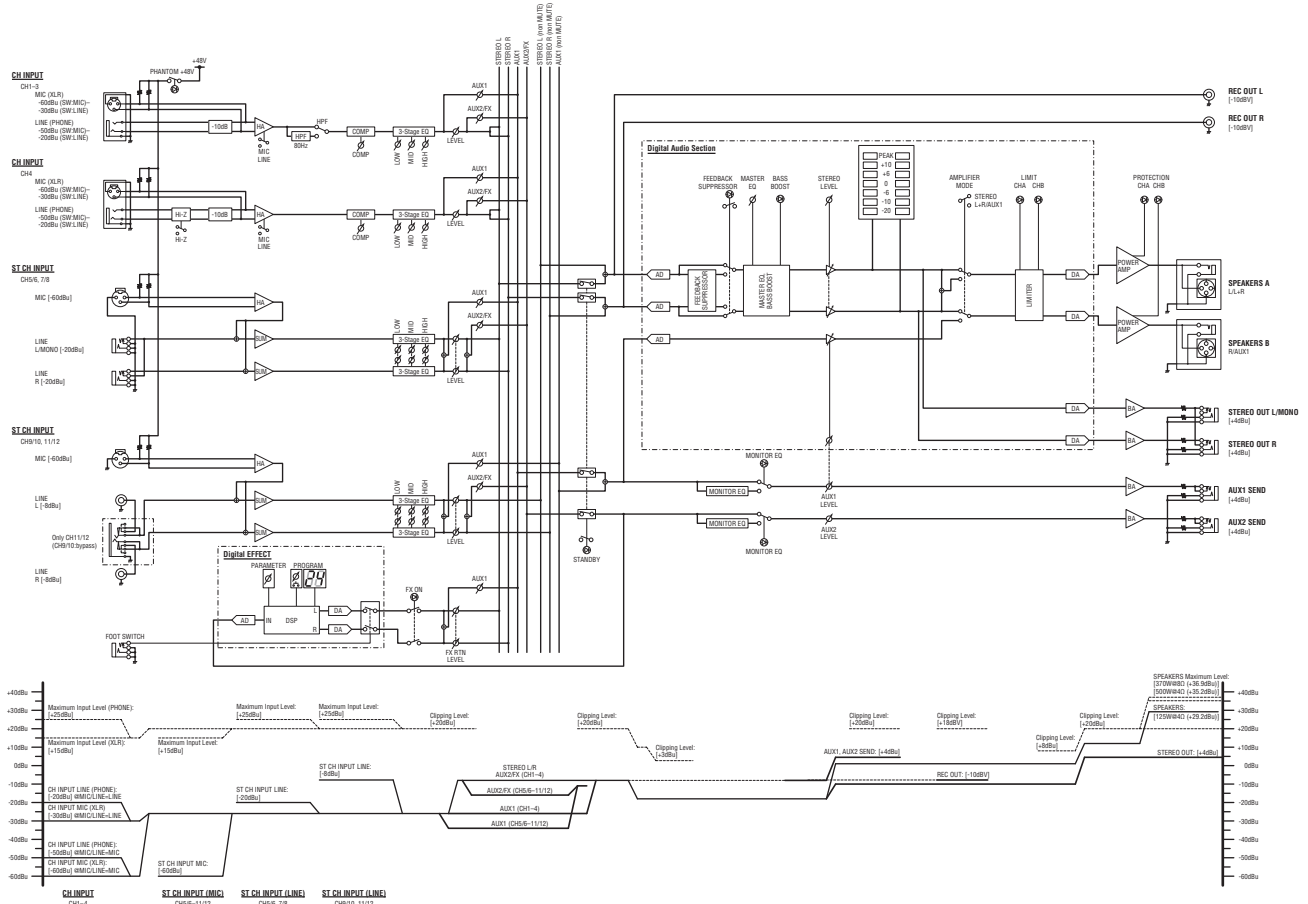

# EMX2 Block and Level Diagrams

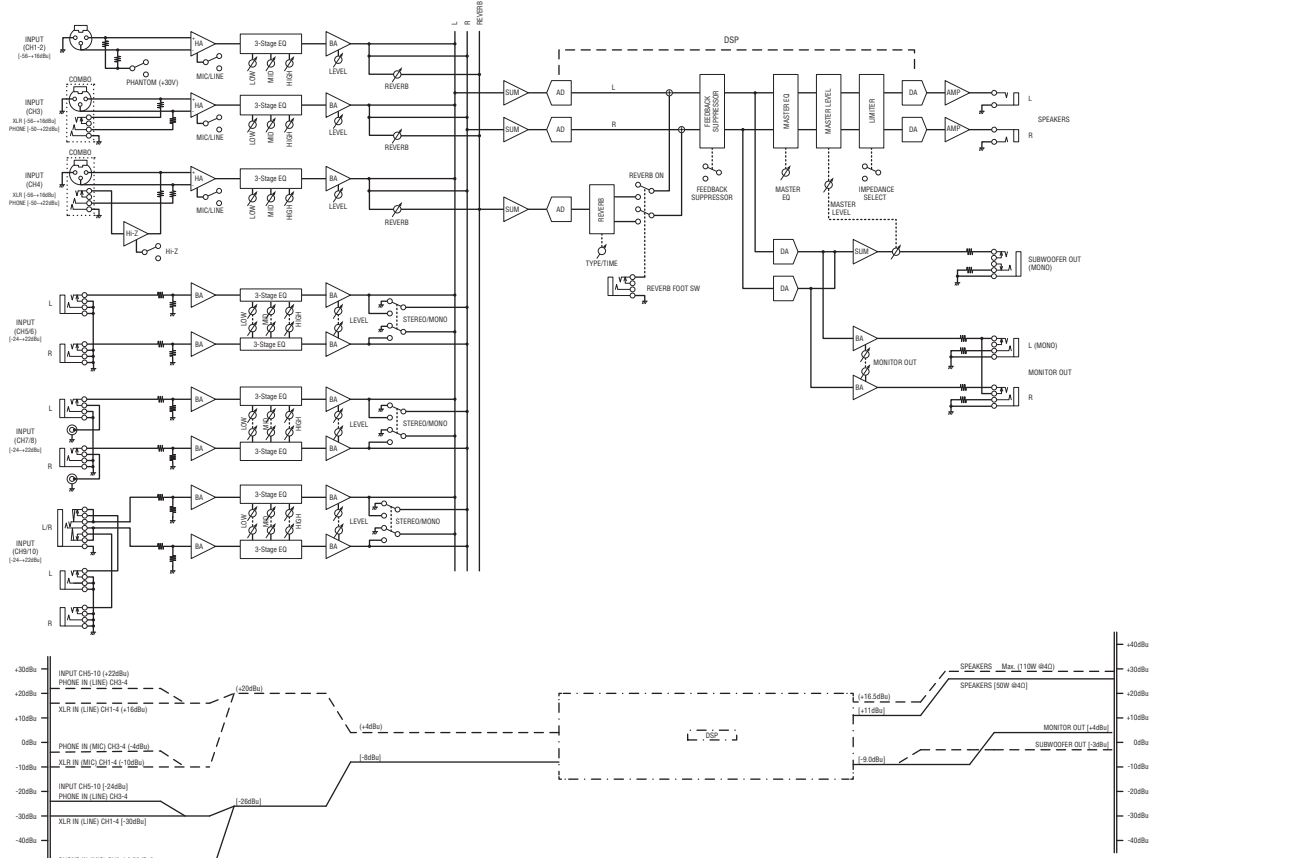

# EMX5016CF Block and Level Diagrams

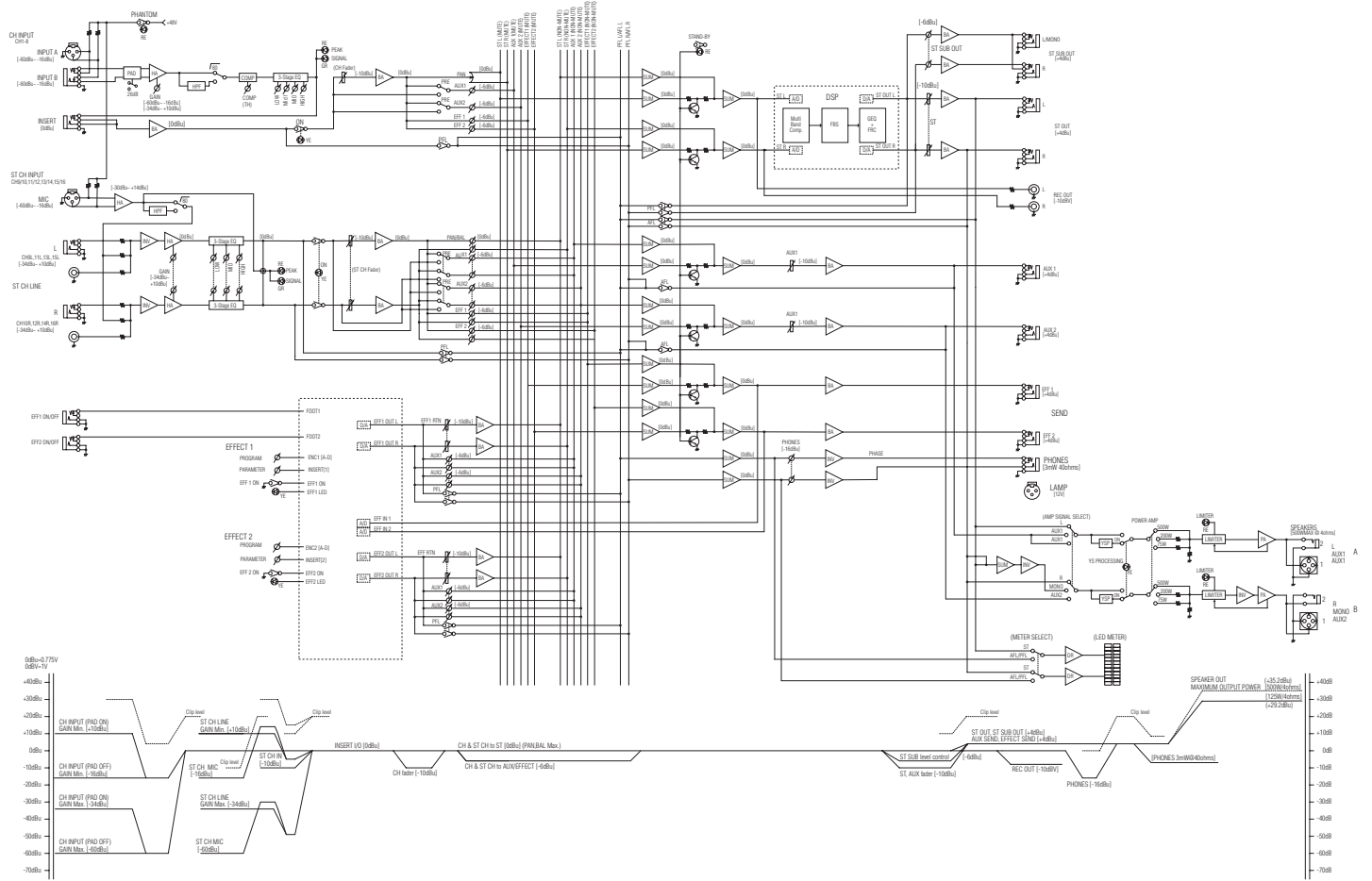

# EMX5014C Block and Level Diagrams

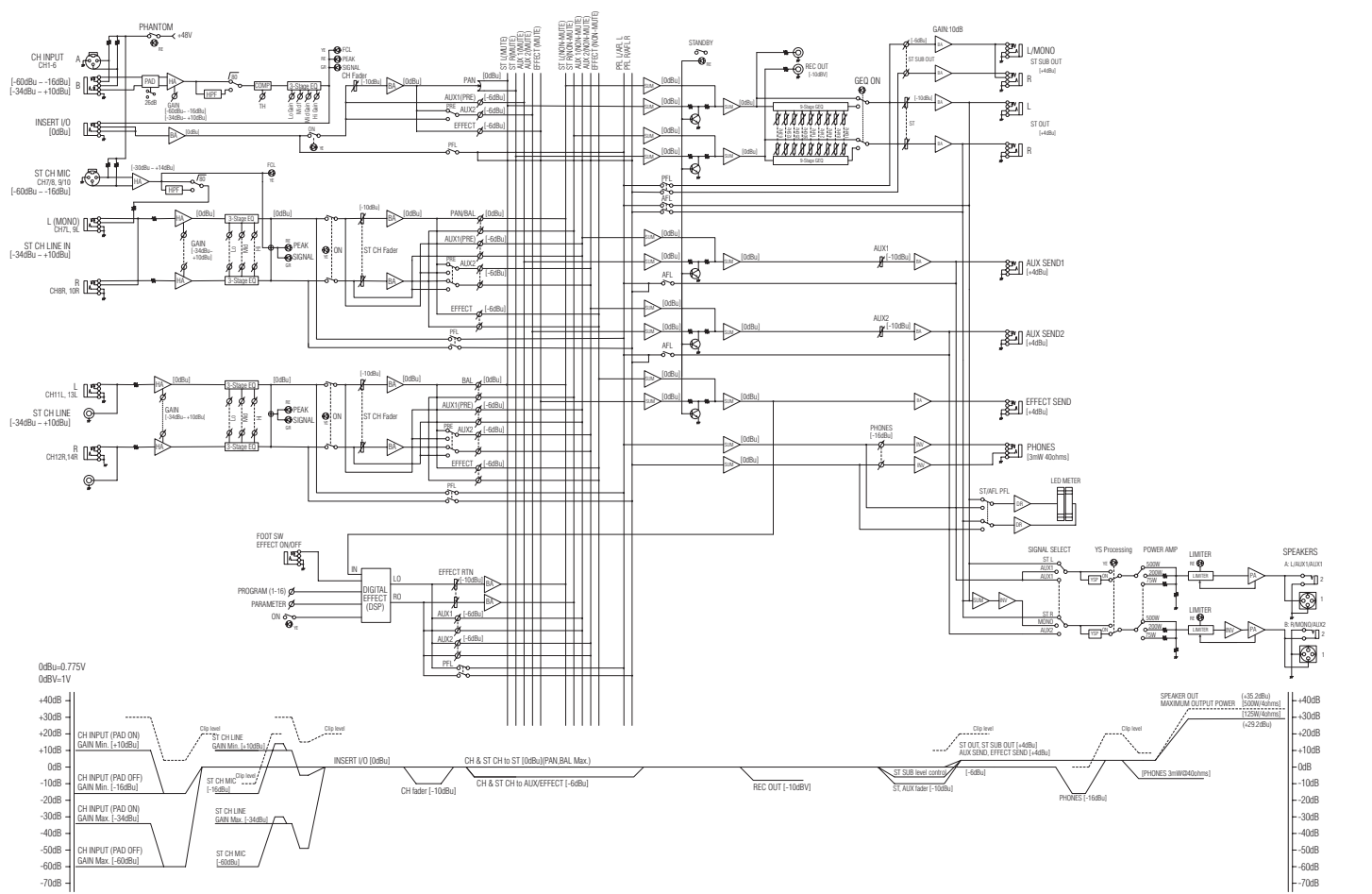



SHARING PASSION & PERFORMANCE

YAMAHA CORPORATION  
P.O.BOX1, Hamamatsu Japan  
[www.yamahaproaudio.com](http://www.yamahaproaudio.com)

\*All specifications are subject to change without notice.

\*All trademarks and registered trademarks are property of their respective owners.